

# FORGE FIRES

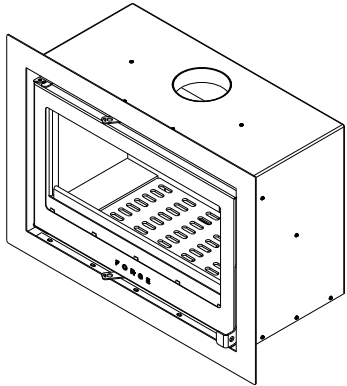
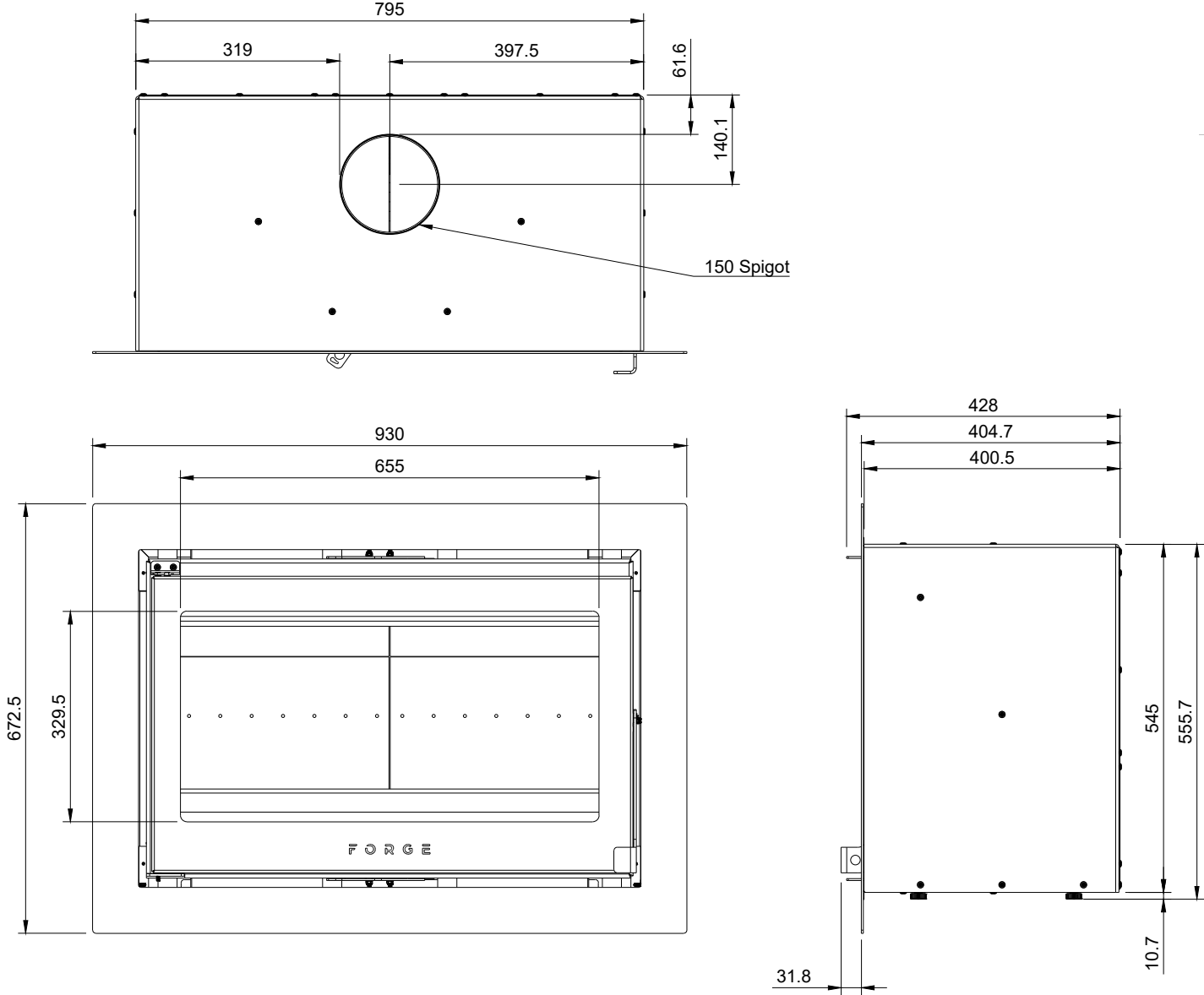

## Forge I80 Insert

FIFP-MS-SGL-800-INS-W-CB v63

This drawing is copyright and remains the property of Signi Fires. It may not be retained, copied, or used without written consent.

Projection	Scale	Sheet	Creation Date
	1:10	A4	2025/06/17