

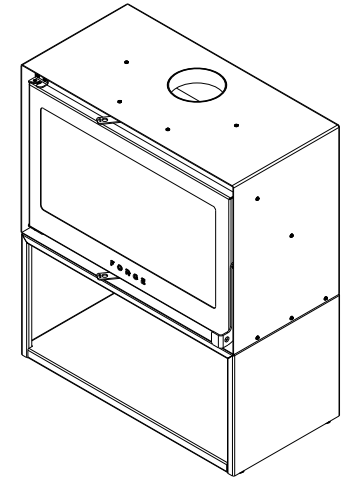

# FORGE FIRES



## Forge F80 Freestanding with High Woodbox

FIFP-MS-SGL-800-WBH-W-CB v1

This drawing is copyright and remains the property of Signi Fires. It may not be retained, copied, or used without written consent.

Projection	Scale	Sheet	Creation Date
	1:12	A4	2025/05/30

# FORGE FIRES

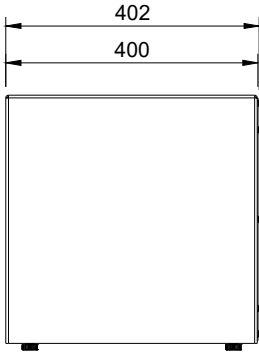
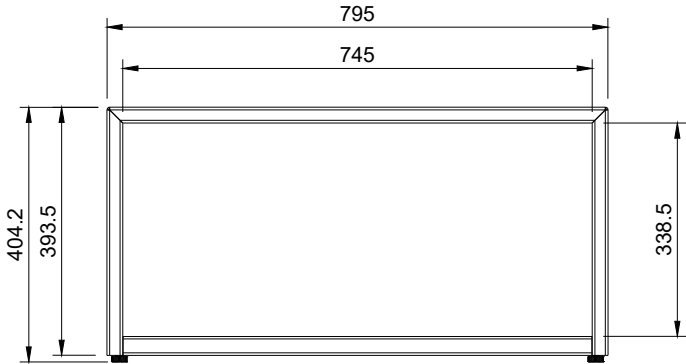
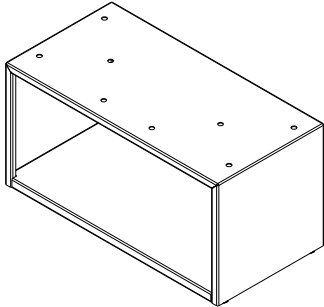
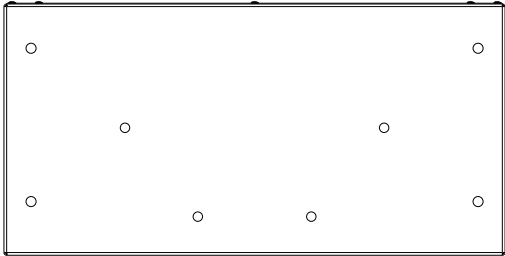

## Forge F80 High Woodbox

FIFP-SGL-Wood Box ASM-0500-UP-CBA

This drawing is copyright and remains the property of Signi Fires. It may not be retained, copied, or used without written consent.

Projection	Scale	Sheet	Creation Date
	1:12	A4	2025/05/30