

FORGE FIRES

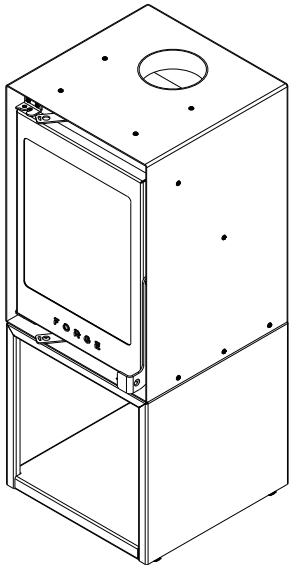
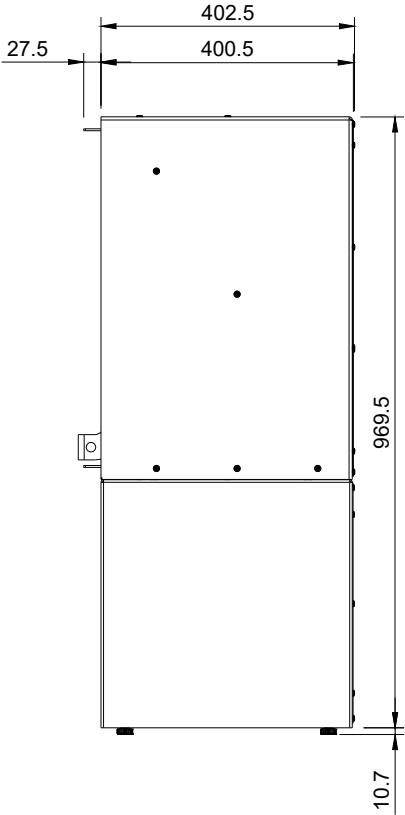
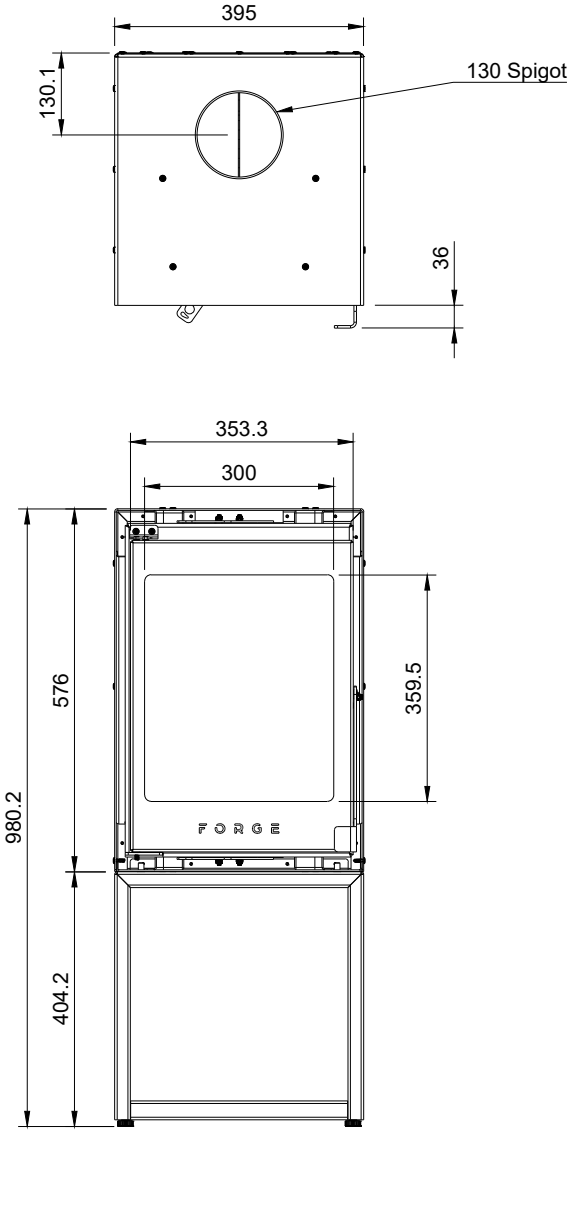

Forge F40 Freestanding with High Woodbox

FURFP-MS-SGL-400-WBH-W-CB v22

This drawing is copyright and remains the property of Signi Fires. It may not be retained, copied, or used without written consent.

Projection	Scale	Sheet	Creation Date
	1:12	A4	2025/04/15

FORGE FIRES

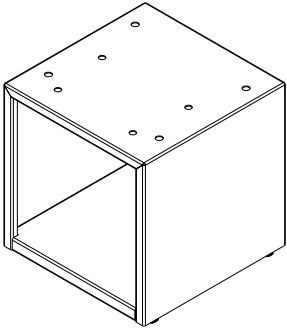
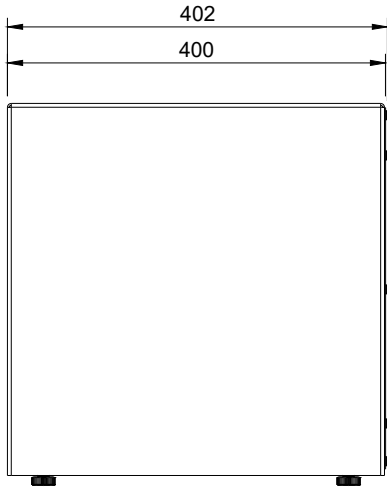
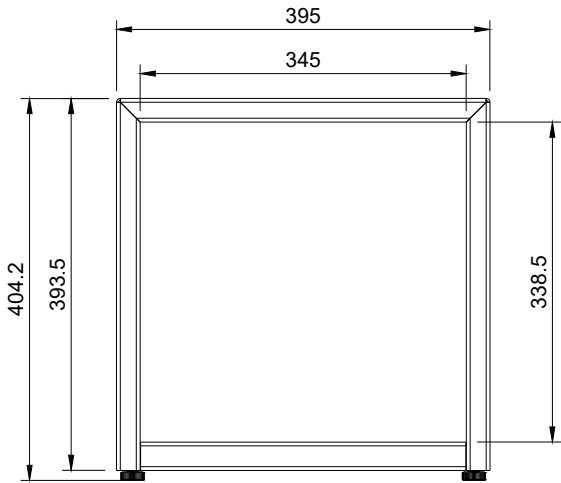
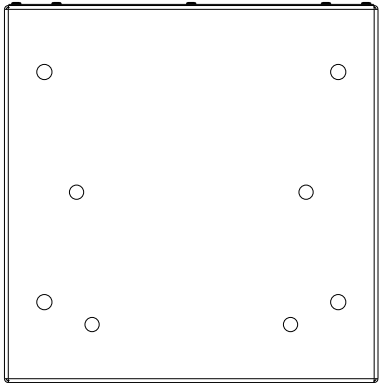

Forge F40 High Woodbox

FURFP-SGL-Wood Box ASM-0500-UP-CBA

This drawing is copyright and remains the property of Signi Fires. It may not be retained, copied, or used without written consent.

Projection	Scale	Sheet	Creation Date
	1:8	A4	2025/04/15